

Hurricane-LX800 EPIC Single Board Computer

Technical Manual

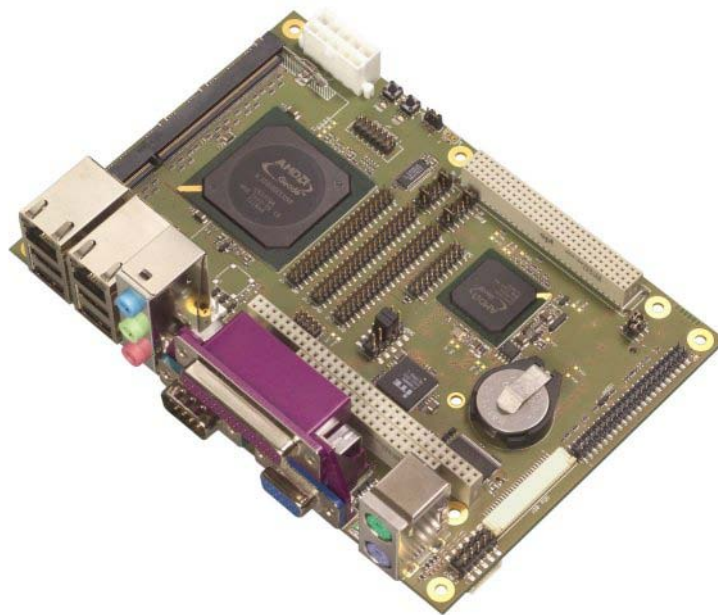

Technical Manual Hurricane-LX800

LiPPERT Document: TME-EPIC-HURLX-R3V5 Revision 3.5

Copyright ©2011 LiPPERT Embedded Computers GmbH, All rights reserved

Trademarks

MS-DOS, Windows, Windows 95, Windows 98, Windows NT and Windows XP are trademarks of Microsoft Corporation. PS/2 is a trademark of International Business Machines, Inc. Intel and Solid State Drive are trademarks of Intel Corporation. Geode is a trademark of Advanced Micro Devices. PC/104 is a registered trademark of PC/104 Consortium. All other trademarks appearing in this document are the property of their respective owners.

Disclaimer

Contents and specifications within this technical manual are subject of change without notice.

LiPPERT Embedded Computers GmbH provides no warranty with regard to this technical manual or any other information contained herein and hereby expressly disclaims any implied warranties of merchantability or fitness for any particular purpose with regard to any of the foregoing. LiPPERT Embedded Computers GmbH assumes no liability for any damages incurred directly or indirectly from any technical or typographical errors or omissions contained herein or for discrepancies between the product and the technical manual. In no event shall LiPPERT Embedded Computers GmbH be liable for any incidental, consequential, special, or exemplary damages, whether based on tort, contract or otherwise, arising out of or in connection with this user's guide or any other information contained herein or the use thereof.

Table of Contents

1	Overview	1
1.1	Introduction	1
	Features	1
	Block Diagram.....	3
1.2	Ordering Information.....	4
	Hurricane-LX800 Models	4
	Cable Sets and Accessories	4
1.3	Specifications	4
	Electrical Specifications.....	4
	Environmental Specifications.....	4
	MTBF.....	5
	Mechanical	5
2	Getting Started	6
2.1	Connector Locations	6
	Top	6
	Bottom	7
2.2	Hardware Setup.....	8
3	Module Description	9
3.1	Processor	9
3.2	I/O Companion	10
3.3	Graphics-Controller	11
	SVGA Configuration	11
	VGA Connector	12
	Flat Panel and LVDS Configuration	13
	Flat Panel Connector	13
	Flat Panel Backlight Connector	14
	LVDS Connector	14
	LVDS Color Mapping	14
	Display Voltage Selector.....	15
3.4	Micrel KSZ8842 Ethernet Switch.....	16
	Ethernet-RJ 45-Connectors.....	16
	USB-Connectors.....	16

3.5	On Board Power Supply	16
	Power Connector (J25, Top)	17
3.6	EIDE Port	18
	EIDE Connector (JHDD1, Top)	18
3.7	PS/2 Keyboard / Mouse Interface	19
3.8	USB 2.0 Ports	19
3.9	Serial Ports	20
	Serial Jumper Settings (J26)	20
	COM1 Port Connector (P1)	21
	COM2 Port Connector (J19, Top)	21
3.10	Parallel Port LPT1	21
	LPT1 Connector (P1)	22
3.11	Audio Interface	23
	Line Out (middle)	23
	Line In (above)	23
	Microphone In (below)	23
3.12	Watchdog	24
	Watchdog programming	24
3.13	On Board LED indicators	25
3.14	Power-Button	25
3.15	Reset-Button	25
3.16	Internal Battery	25
3.17	Front panel Header (J31)	25
3.18	PC/104-Plus Bus Interface (J22)	26
3.19	Mini-PCI Bus Interface (J17)	27
3.20	PC/104 Bus Interface (J21)	28
3.21	High Speed Data Input Port (J3, Top)	29
3.22	GPIO Header (J13, Top)	30
3.23	Analog Inputs and PWM Outputs (J12, Top)	31
3.24	REQ#/GNT# Select Panel (J5=REQ#, J6=GNT#, Top)	31
3.25	LPC Header (J8, Top)	32
3.26	Floppy connector (J20, Top)	32

3.27	uDOC Header (J16, Top).....	33
3.28	Fan Header (J11, Top)	33
3.29	LEMT functions.....	34
4	Using the Module	35
4.1	BIOS.....	35
	Configuring the XpressROM BIOS.....	35
	Trouble Shooting BIOS Settings.....	42
4.2	Drivers	42
4.3	Programming GPIO Signals	43
4.4	Handling Of Analog Inputs	44
4.5	Temperature readout	44
4.6	PWM Outputs	45
5	Address Maps	46
5.1	Memory Address Map	46
5.2	I/O Address Map.....	47
5.3	Interrupts.....	47
5.4	DMA Channels.....	49
	Appendix A, Contact Information	A
	Appendix B, Additional Information	B
B.1	Additional Reading.....	B
B.2	PC/104 and PC/104-Plus Specifications.....	B
	Appendix C, Getting Help	C
	Appendix D, Revision History	D

1 Overview

1.1 Introduction

With the Hurricane, LiPPERT offers a high-performance EPIC board with AMD's Geode™ LX processor with very low power requirements. The board integrates all peripherals needed to build an embedded PC on a small 115 mm x 165 mm (4.5" x 6.5") printed circuit board. Together with a CS5536 I/O companion and a Super I/O chip, the board is a complete PC with all the standard peripherals already on board. There is graphics controller with VGA, LVDS, and parallel TFT adapters to connect many sorts of display terminals. Backlighting is provided for LCD modules.

Two fast 100/10BaseT Ethernet ports, RS232/RS422/RS485 serial ports, and four USB 2.0 host ports handle the communication with external devices. There are PS/2 connectors for keyboard and mouse as well as a parallel printer port available. Sound I/O according to AC97 is supported, too. An IDE ATA100 adapter allows connection of hard disk or CD drives. Applications that require non-moving storage can use the built-in µDOC interface and connect a suitable Flash Drive to it.

The Hurricane is powered by a micro ATX supply and supports ACPI, advanced power management and PCI power management. Additionally, digital and analog I/O is available for the application. There is a high speed data input port for 8 bit data capture or video input with 300 Mb/s isochronous speed integrated to facilitate fast data acquisition.

System expansion is easily done using the PC/104-Plus, the PC/104 or the Mini-PCI- connectors and adding suitable specialized I/O modules.

Features

CPU:

- AMD Geode™ LX800 @ 500MHz

Cache Memory:

- 64 KB/64 KB Level1 I/D caches
- TLB
- 128KB Level2 cache
- Efficient Prefetch

Main Memory:

- One DDR333 SODIMM Module, up to 1GB
- Recommended: 256MB at minimum

Chipset:

- AMD CS5536 companion device

Extension slots:

- 1 x 32-bit PC/104-Plus
- 1 x 16-bit PC/104 with full DMA capability
- 1 x Mini-PCI-
- 1 x LPC Bus on IDC20 pin Header

Interfaces:

- Dual Ethernet 10/100BaseT
- ATA-6 EIDE (Ultra DMA-100)
- PS/2 Keyboard
- PS/2 Mouse
- Floppy connector (flat foil)

- 4 x USB 2.0 host ports, 1 x device (Type A Plug)
- μ DOC Header for USB 2.0 Flash drives
 - 2 x RS232/RS485 software selectable serial ports
- 1 x parallel port
- 5.1 Audio
 - Line-In (left/right) shared with Surround (left/right)
 - Line-Out (left/right)
 - Microphone-In shared with Subwoofer/Center
- VGA monitor up to 1920 x 1440 pixels at 85Hz
- 18 Bit parallel TFT and 24 Bit LVDS Flat Panel up to 1600 X 1200 at 60Hz
- 16 Bit High Speed Data Input Port
- 30 Digital GPIOs
- 8 Analog Inputs (8 Bit)
- 4 PWM Outputs
- PWM Controlled Fan (5V)
- 10 Pin Mini ATX Power supply
- SM-Bus
- Lippert Enhanced Management Technology (LEMT)

Other configurations are possible at high order volumes.

Block Diagram

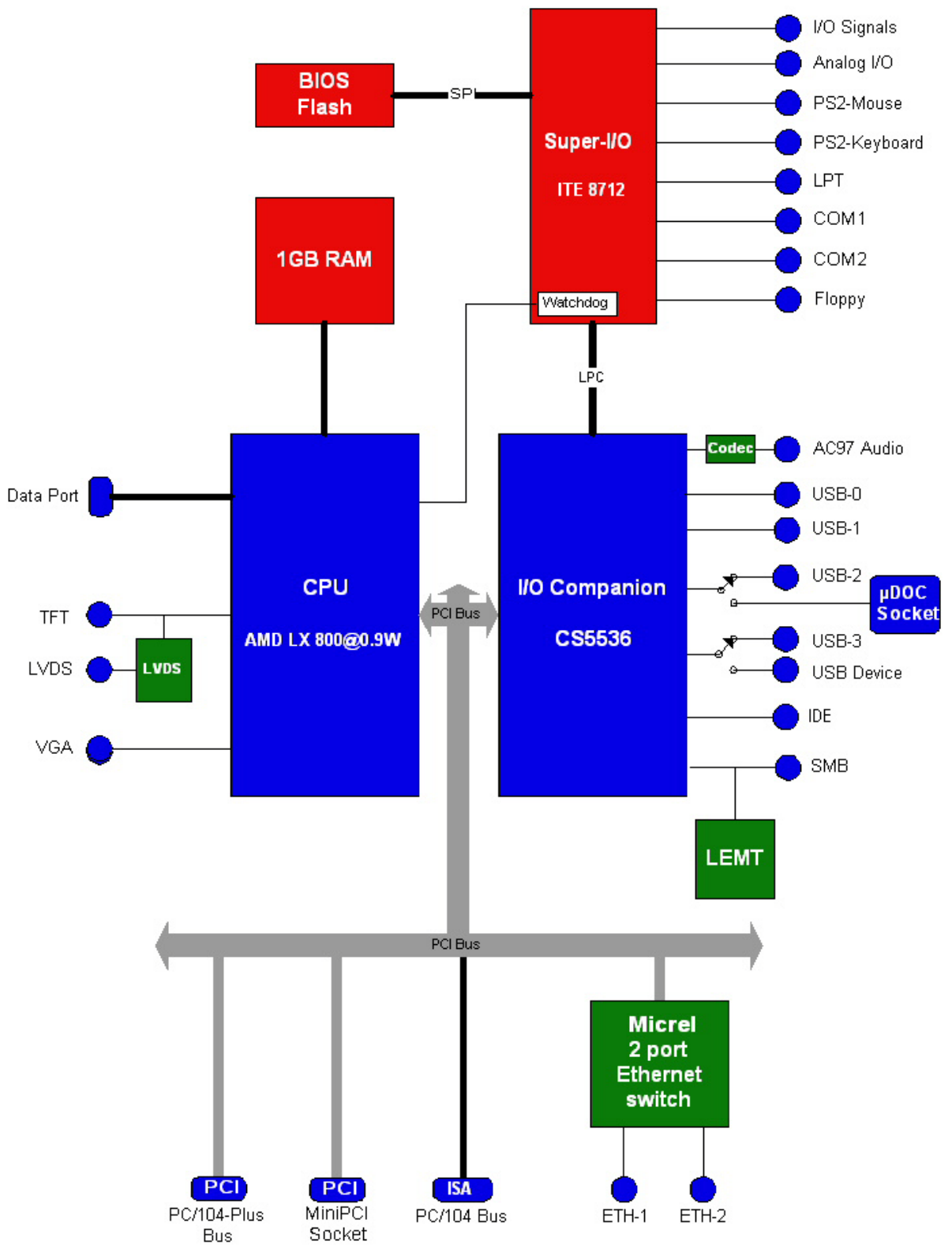

1.2 Ordering Information

Hurricane-LX800 Models

Order number	Description
810-0001-10	Hurricane-LX800, CPU board with AMD Geode LX800 (500 MHz) processor. Operating temperature range: -20°C ... +60°C
910-0001-10	Hurricane-LX800, CPU board with AMD Geode LX800 (500 MHz) processor. Operating temperature range: -40°C ... +85°C

Cable Sets and Accessories

There are some options available for the Hurricane-LX800. Please check their availability before ordering.

Order number	Description
863-0010-10	Adapter Cable Set: COM, IDE (44 pin, 2mm), cable adapter 2.5" > 3.5", adapter 3.5" > 2.5", and FDD adapter.

1.3 Specifications

Electrical Specifications

Supply voltage	+5V and +5V standby from 10 Pin Mini ATX connector
Rise time	< 100 ms
Inrush current	2.5 A
Supply voltage tolerance	± 5%
Supply current	max. 1.4 A depending on operating system and RAM typ. 1.05 A (Windows XP idle mode) typ. 0.18 A (running Windows XP Suspend to RAM)

Environmental Specifications

Operating:

Temperature range	-20 ... 60 °C (standard version) -40 ... 85 °C (extended version)
Temperature change	max. 10K / 30 minutes
Humidity (relative)	10 ... 90 % (non-condensing)
Pressure	450 ... 1100 hPa

Non-Operating/Storage/Transport:

Temperature range	-40 ... 85 °C
Temperature change	max. 10K / 30 minutes
Humidity (relative)	5 ... 95 % (non-condensing)
Pressure	450 ... 1100 hPa

2 Getting Started

2.1 Connector Locations

Top

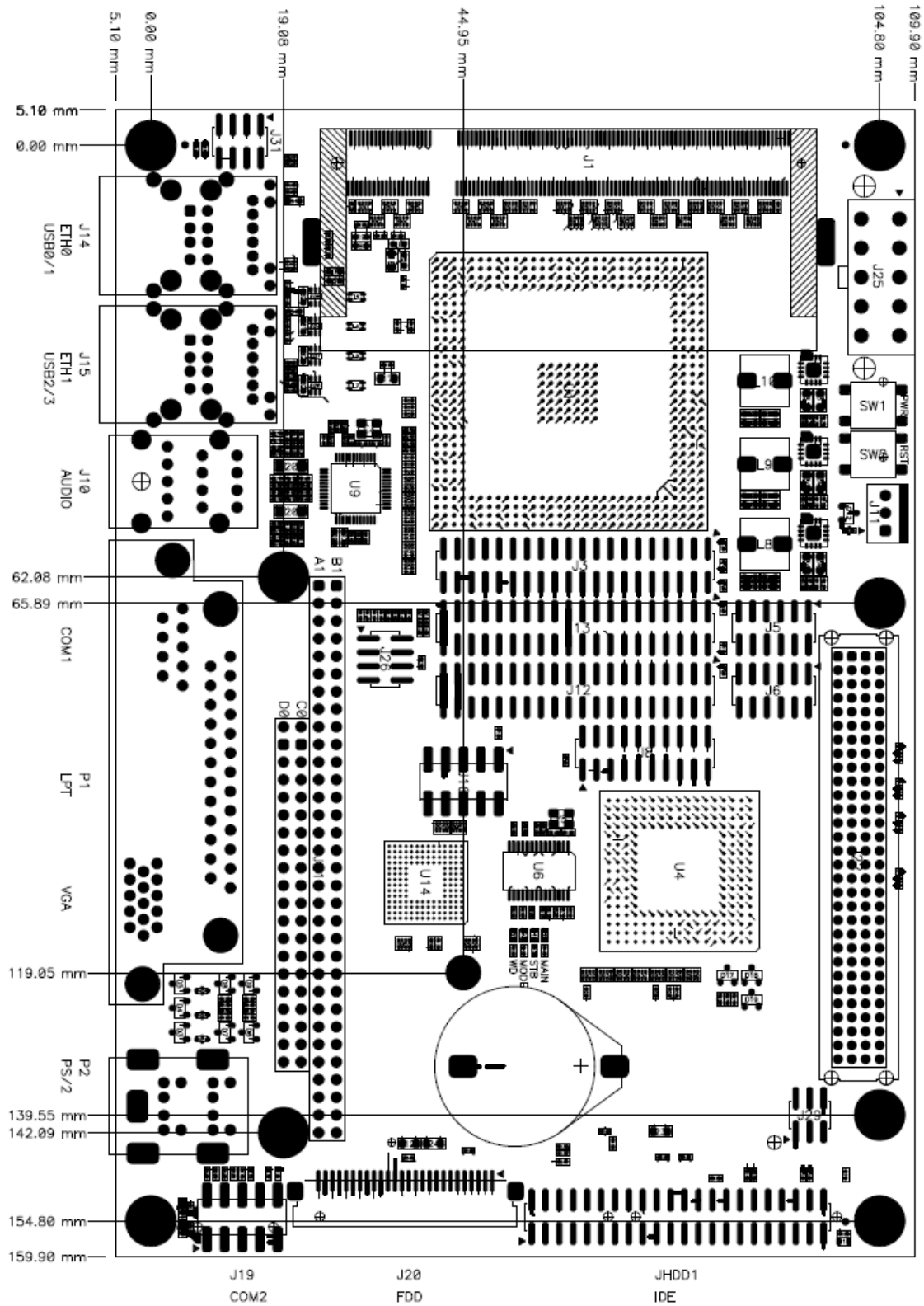

Bottom

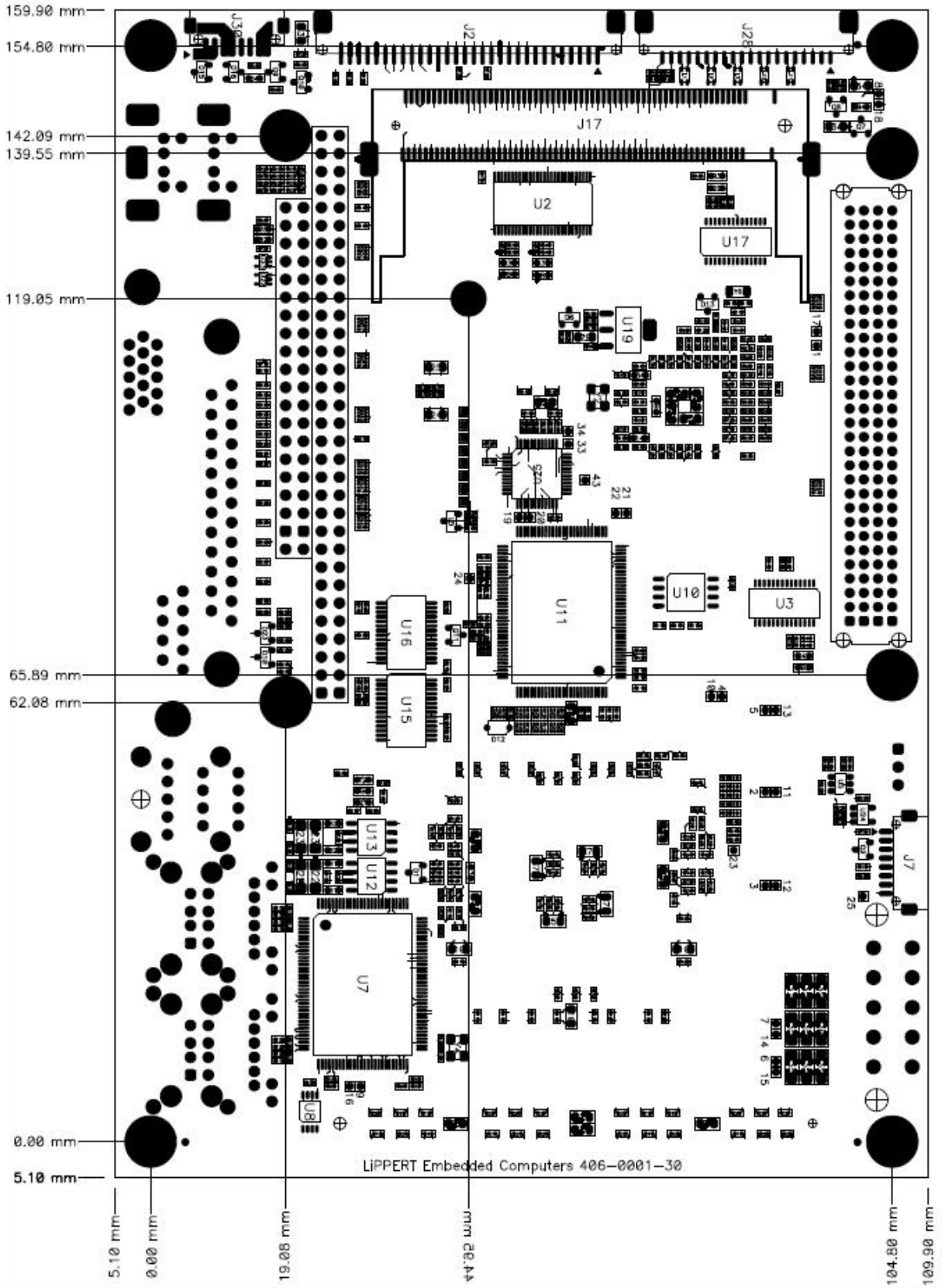

2.2 Hardware Setup



Caution

Be sure to observe the EMC security measures. Make sure you are always at the same potential as the module.



Caution

Never connect or disconnect peripherals like HDD's while the board's power supply is connected and switched on!

Connect the Hurricane-LX800 to a VGA monitor. Connect either PS/2 or USB keyboard and mouse, respectively. Use the 40-wire flat ribbon cable to connect the hard disk. Make sure that the pins match their counterparts correctly and are not twisted. If you plan to use additional other peripherals, now is the time to connect them, too. Connect a 5 volt, 3 amps power supply to the power connector and switch the power on.



Note *The 3 amps value is the minimum you should have for the standard peripherals mentioned. If you want to use more and/or others, please plan your power budget first! The system will not work if there is not enough supply current for all your devices.*

The display shows the BIOS messages. If you want to change the standard BIOS settings, press the <F1> key to enter the BIOS menu. See chapter 4.1 for BIOS setup details.

If you need to load the BIOS default values, they can be automatically loaded at boot time. To achieve this, push the Reset-Button five times while the system is booting.

The Hurricane-LX800 boots from CD drives, USB floppy, USB stick, or hard disk. Provided that any of these is connected and contains a valid operating system image, the display then shows the boot screen of your operating system.

The Hurricane-LX800 does not need any cooling measures, neither at standard environment temperatures from – 20 °C ... +60 °C nor in the extended range of -40 °C ... +85 °C.

3 Module Description

3.1 Processor

AMD Geode-LX800

The AMD Geode LX 800@0.9W processor delivers the best performance per watt in the industry today, providing X86 power and versatility to embedded products. Its architecture and high level of integration guarantees longer battery life and allows very small designs, while delivering full X86 functionality.

The AMD Geode LX 800 processor consumes a maximum power of 3.9W and 1.8W typical at 500 MHz, enabling systems that only need to be passively cooled.

The x86 compatibility allow designers to focus on developing end products that efficiently meet consumer needs without being concerned with software porting or compatibility issues.

Coupled with the AMD Geode™ CS5536 companion device, the combined chipset, which operates at 1.9W typical at 433MHz and at 2.4W typical at 500MHz, offers a complete set of features that deliver full desktop functionality to embedded and portable devices.

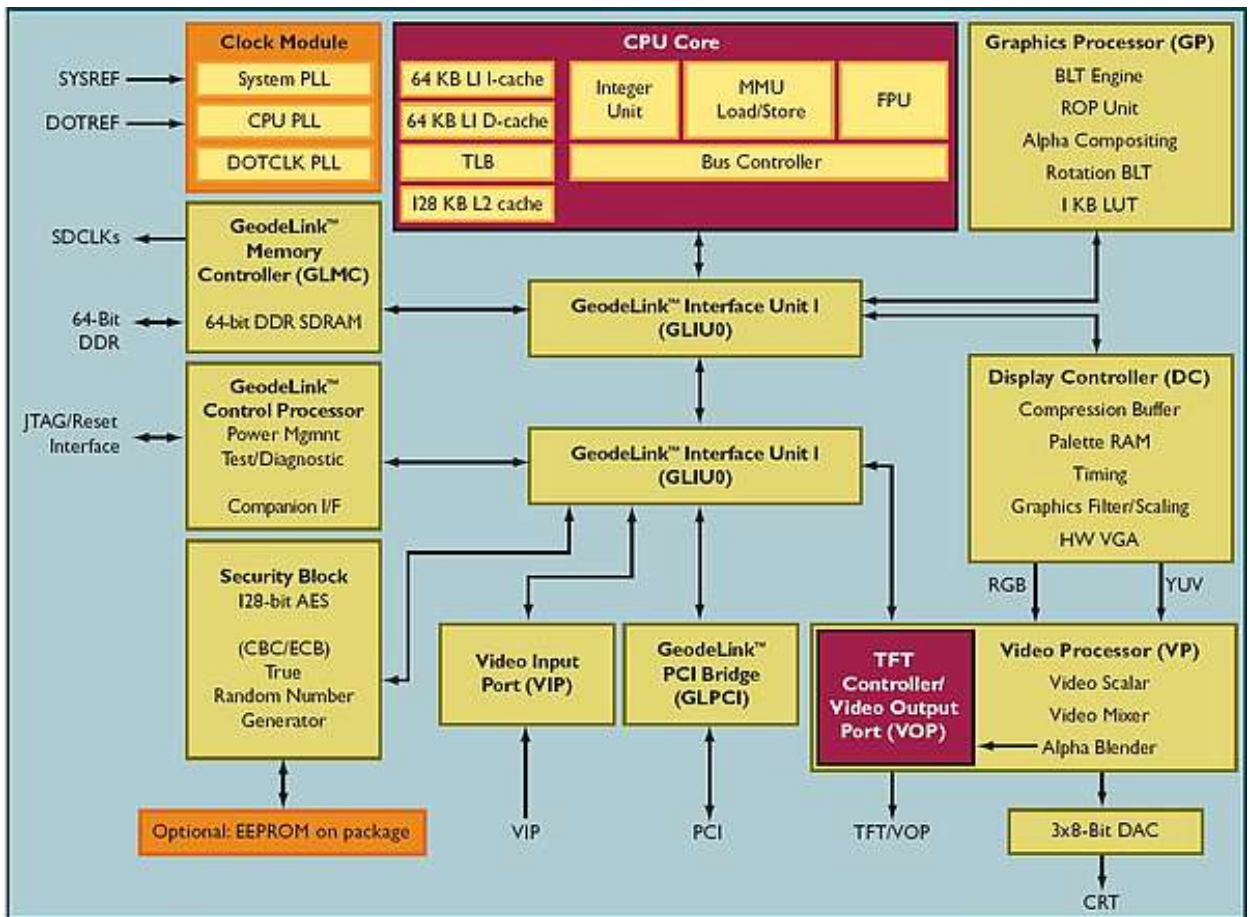

Processor functional blocks are

- CPU Core

- GeodeLink™ Control Processor
- GeodeLink Interface Units
- GeodeLink Memory Controller
- Graphics Processor
- Display Controller
- Video Processor
- Video Input Port
- GeodeLink PCI Bridge
- Security Block

For further information, please refer to the data book of the AMD Geode™ LX 800

3.2 I/O Companion

AMD Geode™ CS5536 companion device

The AMD Geode™ CS5536 companion device is designed to work with an integrated processor North Bridge component such as the AMD Geode™ LX processor. Together, the Geode LX processor and Geode CS5536 companion device provide a system-level solution well suited for the high-performance and low-power needs of a host of embedded devices including digital set-top boxes, mobile computing devices, thin client applications, and single board computers.

The internal architecture uses a single, high-performance modular structure based on GeodeLink™ architecture. This architecture yields high internal speed (over 4 GB/s) data movement and extremely versatile internal power management. The GeodeLink architecture is transparent to application software. Communication with the Geode LX processor is over a 33/66 MHz PCI bus. The Geode CS5536 companion device incorporates many I/O functions, including some found in typical Super I/O chips, simplifying many system designs. Since the graphics subsystem is entirely contained in the Geode LX processor, system interconnect is simplified. The device contains state-of-the-art power management that enables systems, especially battery powered systems, to significantly reduce power consumption. Audio is supported by an internal controller, designed to connect to multiple AC97 compatible codecs. An IR (infrared) port supports all popular IR communication protocols.

A LPC (low pin count) port is provided to facilitate connections to a Super I/O should additional expansion, such as a floppy drive, be necessary, and/or to an LPC ROM for the system BIOS.

The hard disk controller is compatible to the ATA-5 specification. The bus mastering IDE controller includes support for two ATA-compliant devices on one channel. The CS5536 companion device provides four Universal Serial Bus (USB) 2.0 compliant ports, supporting low speed, full speed, and high speed connections. All four ports are individually automatically associated with either the Open Host Controller Interface (OHCI) or the Enhanced Host Controller Interface (EHCI) depending on the attached device type. A battery-backed real-time clock (RTC) keeps track of time and provides calendar functions.

A suite of 82xx devices provides the legacy PC functionality required by most designs, including two PIC (programmable interrupt controllers), one PIT (programmable interval timer) with three channels, and DMA (direct memory access) functions. The CS5536 companion device contains eight MFGPT's (multi-function general purpose timers) that can be used for a variety of functions. A number of GPIOs (general purpose input/outputs) are provided, and are assigned to system functions on power-up (i.e., LPC port).

State-of-the-art power management features are attained with the division of the device into two internal power domains. The GPIOs and multi-function timers are distributed into each domain allowing them to act as wakeup sources for the device. The device provides full ACPI (Advanced Configuration Power Interface) compliance and supports industry-standard Wakeup and Sleep modes.

3.3 Graphics-Controller

The graphics controller is integrated in the Geode LX and does high performance 2D-graphics handling. CRT monitors can be used as well as TFT- or LVDS displays. Therefore, different connectors are on the board. It is possible to switch between CRT and TFT via BIOS or driver settings. It is also possible to use a CRT and a TFT/LVDS display simultaneously (driver setting), but only with the same graphics content on both displays.

The Hurricane LX800 supports 3,3V and 5V TFT displays up to 18bit, and LVDS displays with 18/24bit interfaces with unconventional signal configuration. The display type and resolution can be selected in BIOS **Motherboard Device Configuration à Video and Flat Panel Configuration**.

SVGA Configuration

The VGA connector is located at the I/O panel. The following display modes are supported:

Resolution	Color Depth (bpp)	Refresh Rate (Hz)	Dot Clock (MHz)	Min. GLIU Frequency (MHz)
640 x 480	8, 16, or 24/32	60	25.175	75
	8, 16, or 24/32	70	28.560	75
	8, 16, or 24/32	72	31.500	75
	8, 16, or 24/32	75	31.500	75
	8, 16, or 24/32	85	36.000	75
	8, 16, or 24/32	90	37.889	400
	8, 16, or 24/32	100	43.163	400
800 x 600	8, 16, or 24/32	60	40.000	75
	8, 16, or 24/32	70	45.720	75
	8, 16, or 24/32	72	49.500	75
	8, 16, or 24/32	75	49.500	75
	8, 16, or 24/32	85	56.250	75
	8, 16, or 24/32	90	60.065	400
	8, 16, or 24/32	100	68.179	400
1024 x 768	8, 16, or 24/32	60	65.000	75
	8, 16, or 24/32	70	75.000	100
	8, 16, or 24/32	72	78.750	100
	8, 16, or 24/32	75	78.750	100
	8, 16, or 24/32	85	94.500	100
	8, 16, or 24/32	90	100.187	400
	8, 16, or 24/32	100	113.310	400
1152x864	8, 16, or 24/32	60	81.600	100
	8, 16, or 24/32	70	97.520	100
	8, 16, or 24/32	72	101.420	200
	8, 16, or 24/32	75	108.000	200
	8, 16, or 24/32	85	119.650	200
	8, 16, or 24/32	90	129.600	400
	8, 16, or 24/32	100	144.000	400
1280 x 1024	8, 16, or 24/32	60	108.000	200
	8, 16, or 24/32	70	129.600	200
	8, 16, or 24/32	72	133.500	200

Resolution	Color Depth (bpp)	Refresh Rate (Hz)	Dot Clock (MHz)	Min. GLIU Frequency (MHz)
	8, 16, or 24/32	75	135.000	200
	8, 16, or 24/32	85	157.500	200
	8, 16, or 24/32	90	172.800	400
	8, 16, or 24/32	100	192.000	400
1600 x 1200	8, 16, or 24/32	60	162.000	200
	8, 16, or 24/32	70	189.000	200
	8, 16, or 24/32	72	198.000	233
	8, 16, or 24/32	75	202.500	233
	8, 16, or 24/32	85	229.500	266
	8, 16, or 24/32	90	251.182	400
	8, 16, or 24/32	100	280.640	400
1920x1440	8, 16, or 24/32	60	234.000	266
	8, 16, or 24/32	70	278.400	400
	8, 16, or 24/32	72	288.000	400
	8, 16, or 24/32	75	297.000	400
	8, 16, or 24/32	85	341.349	400

VGA Connector

Connector type: D-SUB15, female
 Matching connector: D-SUB15, male

Pin	Signal
1	RED
2	GREEN
3	BLUE
4	NC
5	GND
6	GND
7	GND
8	GND
9	+ 5 Volts (VGA)
10	GND
11	NC
12	DDC_DATA
13	HSYNC
14	VSYNC
15	DDC_CLK

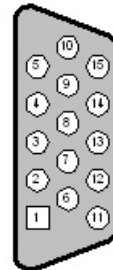

Flat Panel and LVDS Configuration

Flat panel and LVDS have the same display options as shown in the table:

Setting	Possible Values
Flat Panel Type	TFT, LVDS
Resolution	320x240, 640x480, 800x600, 1024x768, 1152x864, 1280x1024, 1600x1200
Data Bus Type	9-24 Bits, 1ppc
Refresh Rate	60 Hz
HSYNC Polarity	High, Low
VSYNC Polarity	High, Low
LP Active Period	Active Only à only active during SYNC Free Running à always active
SHFCLK Active Period	Active Only à only active during SYNC Free Running à always active

To ease usage of these displays it's possible to select the display and backlight supply voltages with the on-board voltage selector jumpers. (Jumper J29, see below)

Flat Panel Connector

Connector J2

Connector type: IDC30 pin header 2.00 mm
Matching connector: IDC30 pin female connector 2.00 mm

Pin	Signal	Pin	Signal
1	GND	2	FPCLK
3	HSYNC	4	VSYNC
5	GND	6	R0 (LSB Red)
7	R1	8	R2
9	R3	10	R4
11	R5 (MSB Red)	12	GND
13	G0 (LSB Green)	14	G1
15	G2	16	G3
17	G4	18	G5 (MSB Green)
19	GND	20	B0 (LSB Blue)
21	B1	22	B2
23	B3	24	B4
25	B5 (MSB Blue)	26	GND
27	EN	28	VLCD-SW
29	VLCD-SW	30	GND

Flat Panel Backlight Connector

Connector J30

Connector type: Hirose DF13 8 pin

Matching connector: Hirose DF13-8S-1.25C, part number 536-0007-0 00

Pin	Signal	Pin	Signal
1	+12 Volts	2	+12 Volts
3	+5 Volts	4	+5 Volts
5	EN	6	NC
7	GND	8	GND

LVDS Connector







Connector J28

Connector type: Hirose DF14 20-pin header

Matching connector: Hirose DF14-20S-1.25C, part number 538-0059-7 00

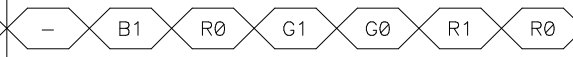
Pin	Signal	Pin	Signal
1	SW-VDD	2	SW-VDD
3	GND	4	GND
5	TX3-	6	TX3+
7	GND	8	TXCLK-
9	TXCLK+	10	GND
11	TX2-	12	TX2+
13	GND	14	TX1-
15	TX1+	16	GND
17	TX0-	18	TX0+
19	DDC Clk	20	DDC Data

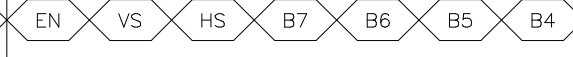
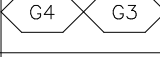
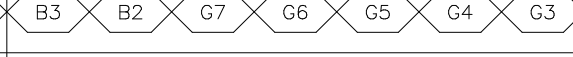
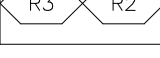
LVDS Color Mapping

Diff.pairs	Previous cycle	Next cycle
Clock		
TX3		
TX2		
TX1		
TX0		

Display Voltage Selector

Jumper J29

Connector type:

IDC6 pin header

Matching part:

jumper 2.00 mm

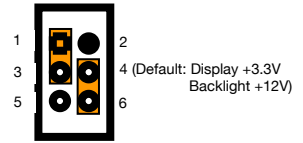

Use a 2 mm jumper between 1-3 or 3-5 to select the backlight voltage.

Use a 2 mm jumper between 2-4 or 4-6 to select the display voltage.

Pin	Signal	Pin	Signal
1	+12 volts	2	+5 volts
3	Backlight voltage	4	Display voltage
5	+ 5 volts	6	+3.3 volts

3.4 Micrel KSZ8842 Ethernet Switch

The KSZ8842-PMQL is the industry’s first fully managed 2-port switch with a 32 bit/33MHz PCI processor interface. It is a proven, 4th generation, integrated Layer 2 switch that is compliant with the IEEE 802.3u standard.

The KSZ8842-PMQL can be configured as a switch or as a low-latency (<310 nanoseconds) repeater in latency-critical, embedded or industrial Ethernet applications. For industrial automation applications, the KSZ8842-PMQL can run in half duplex mode regardless of the application.

The KSZ8842-PMQL offers an extensive feature set that includes tag/port-based VLAN, quality of service (QoS) priority management, management information base (MIB) counters, and CPU control/data interfaces to effectively address Fast Ethernet applications.

The KSZ8842-PMQL contains two 10/100 transceivers with patented, mixed-signal, low-power technology three media access control (MAC) units, a direct memory access (DMA) channel, a high-speed, non-blocking, switch fabric, a dedicated 1K entry forwarding table, and an on-chip frame buffer memory.

Ethernet-RJ 45-Connectors

Connectors J14-1, J15-1

Connector type: RJ45 Jack

Matching connector: 8P8C

Pin	Signal
1	TX+
2	TX-
3	RX+
4	PE
5	PE
6	RX-
7	PE
8	PE

LED	Signal	Color
A	Link	Green
B	Activity	Orange

(RJ45) plug

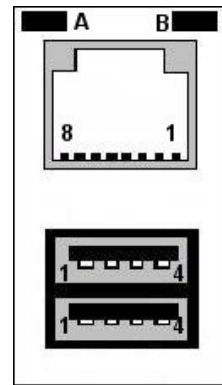

USB-Connectors

Connectors J14-2 (0/1) J15-2 (2/3)

Connector type: USB Jack

Matching connector: USB type A plug

USB1/3 (top), 0/2 (bottom)

Pin	Signal
1	USB_VCC
2	USB-
3	USB+
4	GND

3.5 On Board Power Supply

The on board power supply generates all necessary voltages from the Mini ATX compliant power supply unit. To use a standard ATX 1.3 compliant power supply unit, an adapter is delivered with the board.

The 3.3V (also 5V, 12V, -12V) available on the PC104 Plus Connector is delivered directly from the external power supply unit, so refer to the specification of your power supply unit for information on maximum available power on the PC104 Plus connector.

Power Connector (J25, Top)

Connector type: Molex 10 Pin Mini ATX-Power connector
Matching connector: Molex Mini-Fit Jr.™ Receptacle Housing, Dual Row, UL 94V-0, 10 Circuits, 5556 series and Mini-Fit Plus HCS™ Crimp Terminal 45750

The board itself needs only +5 V and +5 V standby (SBY).

Pin	Signal	Pin	Signal
6	+5 V SBY	1	Power Switch ON #
7	+5 V	2	GND
8	+5 V	3	GND
9	-12 V	4	+12 V
10	GND	5	+3,3 V

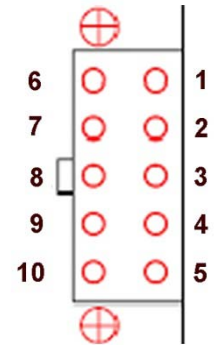

3.6 EIDE Port

An EIDE (Enhanced Integrated Drive Electronics) port is provided by the chipset to connect one drive. The connected device must be set as slave.

To enhance the performance, this port has a 100 MB/s IDE controller in UDMA mode per the ATA-5 specification. The EIDE port is available on a standard 44-pin header (2 mm) for 2.5" hard disks. An adapter cable is available to connect standard EIDE devices with a 40 pin IDC header.

EIDE Connector (JHDD1, Top)

Connector type: IDC44 pin header 2.00 mm
Matching connector: IDC44 pin female connector 2.00 mm

Pin	Signal	Pin	Signal
1	/Reset	2	GND
3	Data7	4	Data8
5	Data6	6	Data9
7	Data5	8	Data10
9	Data4	10	Data11
11	Data3	12	Data12
13	Data2	14	Data13
15	Data1	16	Data14
17	Data0	18	Data15
19	GND	20	NC
21	DRQ0	22	GND
23	Write	24	GND
25	Read	26	GND
27	Ready	28	CSEL
29	DACK0	30	GND
31	IRQ	32	IOCS16-
33	Address1	34	PD66
35	Address0	36	Address2
37	CS1	38	CS3
39	NC	40	GND
41	+5 Volts	42	+5 Volts
43	GND	44	GND

3.7 PS/2 Keyboard / Mouse Interface

Connector type: PS/2
Matching connector: Mini-DIN 6-pin male

PS/2 – Mouse – Connector (P2, above)

Pin	Signal
1	Mouse Data
2	NC
3	GND (Power Supply Mouse)
4	+5 Volts (Power Supply Mouse)
5	Mouse Clock
6	NC

PS/2 – Keyboard – Connector (P2, below)

Pin	Signal
1	Kbd Data
2	NC
3	GND (Power Supply Kbd)
4	+5 Volts (Power Supply Kbd)
5	Kbd Clock
6	NC

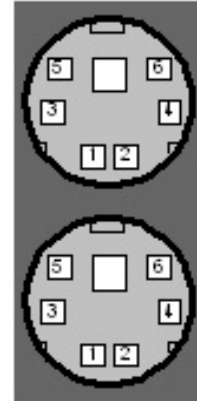

3.8 USB 2.0 Ports

4 standard USB 2.0 host ports are provided at the I/O panel of the Hurricane LX800.

It is possible to use an USB keyboard under MSDOS without special driver software.

Port 3 can be used as USB device port. This feature must be enabled in BIOS under **PCI Bus**. UDC must be enabled; Port 3 assignment should be set to device.

The connectors are located below the Ethernet ports (see Chapter 3.5)

Note: not all keyboard models are supported.

3.9 Serial Ports

COM1 is located at the I/O panel while COM2 is an IDC10 pin header (J19). An adapter cable with a standard DB9 male connector is available. The ports either work in RS232 or RS485 mode, selectable in the BIOS. When entering **Serial and Parallel Ports, COM Port 1 Mode** and **COM Port 2 Mode** can be selected. Termination resistors for RS485 Mode can be set with Jumpers on pin header J26 as described below.

To enable the transmitters of COM1 and COM2 in RS485 mode set the RTS# signal to '1'. Depending on your operating system driver's logic, this may mean setting a (non-inverted) RTS bit to '0' in your application software.

The serial ports are programmable in BIOS setup. When entering **Serial and Parallel Ports**, configuration of the serial ports is accessible.

The following settings are possible for COM1 and COM2:

- Disabled
- 3F8 / IRQ4 (base address / interrupt channel)
- 2F8 / IRQ3 (base address / interrupt channel)
- 3E8 / IRQ4 (base address / interrupt channel)
- 2E8 / IRQ3 (base address / interrupt channel)

The modes can be switched between RS232 and RS485.

Serial Jumper Settings (J26)

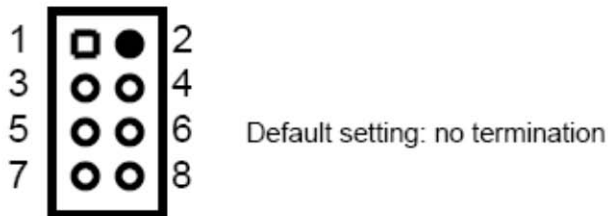

When the jumper is set (1-2, 3-4, 5-6, 7-8), differential pairs (e.g. RX+ and RX-) are terminated with 120Ω between them.

Additionally positive/negative receive lines are pulled up/down with 1kΩ to 5V/GND in order to protect the transceivers of the Hurricane LX800 from overvoltages.

It is recommended to protect the receive lines of the communication partner device in the same way!

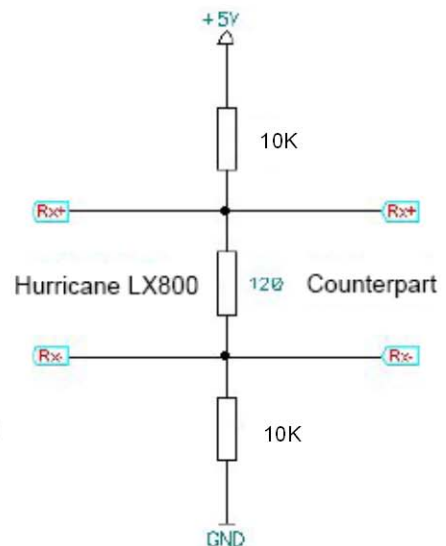

Caution: Termination Resistors **must not** be set in RS232 Mode. Otherwise the Serial Ports will not work.

COM1 Port Connector (P1)

Connector type: D-SUB9, male
 Matching connector: D-SUB9, female

RS232 function (names in brackets for RS485/RS422 function)

Pin	RS232 Signal	RS485 Signal
1	DCD	
2	RXD	RXD-
3	TXD	TXD-
4	DTR	
5	GND	
6	DSR	RXD+
7	RTS	TXD+
8	CTS	
9	NC	

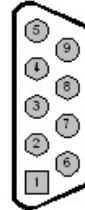

COM2 Port Connector (J19, Top)

Connector type: IDC10 pin header 2.54 mm
 Matching connector: IDC10 pin female connector 2.54 mm

Pin	RS232 Signal	RS485 Signal	Pin	RS232 Signal	RS485 Signal
1	DCD		2	DSR	RXD+
3	RXD	RXD-	4	RTS	TXD+
5	TXD	TXD-	6	CTS	
7	DTR		8	NC	
9	GND		10	+5 V	

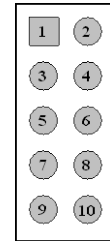

3.10 Parallel Port LPT1

The parallel port is located at the I/O panel.

The parallel port is programmable in BIOS. Entering **Serial and Parallel Ports**, configuration of LPT1 is accessible.

LPT1 Parameter	Possible Settings
Base Address	Disabled, 0x3BC (not recommended, possible conflict with PCI to ISA Bridge), 0x378, 0x278 (not recommended, possible conflict with PCI to ISA Bridge)
Mode	Compatible, PS/2 Bi-directional, EPP 1.7, EPP 1.9
IRQ	Disabled, IRQ 5, IRQ 7, IRQ 9, IRQ 10, IRQ 11
DMA	None, Channel 1, Channel 3

LPT1 Connector (P1)

Connector type: D-SUB25, female
 Matching connector: D-SUB25, male

Pin	Signal	Pin	Signal
1	#Strobe	14	#Auto LF
2	D0	15	#ERR
3	D1	16	#INIT
4	D2	17	Select IN
5	D3	18	GND
6	D4	19	GND
7	D5	20	GND
8	D6	21	GND
9	D7	22	GND
10	#ACK	23	GND
11	BUSY	24	GND
12	PE	25	GND
13	Select		

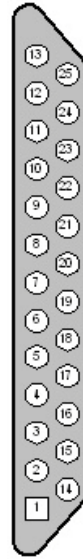

3.11 Audio Interface

The audio signals are located at the boards I/O panel. The signals are:

- Line-In (left/right) shared with Surround (left/right)
- Line-Out (left/right)
- Microphone-In shared with Subwoofer/Center

Driver packages for MS-Windows XP/XPe are available.

Line Out (middle)

Color: green

Connector type: 1/8"

Matching Connector: 1/8" TRS plug

Pin	Signal
1	Line Out Left
2	GND
3	Line Out Right



Line In (above)

Color: blue

Connector type: 1/8"

Matching Connector: 1/8" TRS plug

Pin	Signal
1	Line In Left
2	GND
3	Line In Right



Microphone In (below)

Color: red

Connector type: 1/8"

Matching Connector: 1/8" TRS plug

Pin	Signal
1	Microphone In Left
2	GND
3	Microphone In Right



3.12 Watchdog

A watchdog is implemented by an internal circuit of the ITE8712 Super I/O. It is accessible through some general-purpose ports of the Super I/O controller.

Watchdog programming

Since the Watchdog is disabled in delivery status, it must be set up for proper use.

The Watchdog is an internal feature of the ITE8712 Super I/O. If the Watchdog is activated and the timer is not set back within a programmed amount of time, the board does a system reset.

The following C program is an example how to test the Watchdog function. Programming the Watchdog is quite similar to programming the GPIOs.

This routine is meant to be compiled using gcc under Linux.

```
#include <stdio.h>
#include <sys/io.h>
#include <unistd.h>

#define CONF_ADDR 0x2E
#define CONF_DATA 0x2F

int main()
{
    unsigned char i;
    iopl(3);
    outb(0x87, CONF_ADDR); // puts SIO in configuration mode
    outb(0x01, CONF_ADDR); // (fixed sequence: 0x87,0x01,0x55,0x55)
    outb(0x55, CONF_ADDR);
    outb(0x55, CONF_ADDR);
    outb(0x07, CONF_ADDR); // LDN=0x07
    outb(0x07, CONF_DATA);
    outb(0x72, CONF_ADDR); // set time out value to seconds
    outb(inb(CONF_DATA)|0x80, CONF_DATA);
    outb(0x73, CONF_ADDR); //set time out:
    outb(0x03, CONF_DATA); //0x03 -> 3 seconds
    printf("Watchdog enabled. Press CTRL+C within 5 seconds to stop disarming.\n");
    for(i=0; i<5; i++)
    {
        outb(0x73, CONF_ADDR); //reset time out
        outb(0x03, CONF_DATA);
        printf(".");
        fflush(stdout);
        sleep(1);
    }
    outb(0x73, CONF_ADDR);
    outb(0x00, CONF_DATA); //deactivate watchdog
    printf("\nWatchdog disabled\n");
    iopl(0);
    return 0;
}
```



Note:

Applications MUST NOT CHANGE the watchdog config bits (SIO LDN 7, Index 72h, Bits 6+4), but keep the BIOS's settings to ensure reliable watchdog operation throughout all board revisions.

3.13 On Board LED indicators

- Power: A green LED lights up when ATX Power is supplied.
- Suspend: A red LED lights up after POST is done without error. It flashes in Suspend to RAM mode. Additionally the signal is available at the front panel header (J31) to use an external LED.
- HDD: An orange LED flashes when IDE activity is recognized. Additionally the signal is available at the front panel header (J31) to use an external LED.

3.14 Power-Button

The Power-Button is located next to the 10-Pin ATX power connector. Push button to turn-on/off the board. Additionally the signal is available at the front panel header (J31) to use a cases switch.

3.15 Reset-Button

The Reset-Button is located next to the 10-Pin ATX power connector. Push this button to reset the board. Additionally the signal is available at the front panel header (J31) to use a cases switch.

3.16 Internal Battery

On the board a battery type CR2032 in a battery socket is used to keep RTC time and date running if the board is not powered. As default on delivery the battery is isolated to the upper socket spring contact with an isolation tape. It is recommended to remove this tape if the board is used in the application so that the battery can supply the RTC unit and to reinstall the isolation tape if the board is stored for a longer period. This will prevent the battery from discharge.

3.17 Front panel Header (J31)

Pin	Signal	Pin	Signal
1	Susp. LED (cathode)	2	Susp. LED (anode)
3	IDE LED (cathode)	4	IDE LED (anode)
5	EXT_PWRBTN#	6	GND
7	EXT_RST#	8	GND

3.18 PC/104-Plus Bus Interface (J22)

The PC/104-Plus bus is a modification of the standard PCI bus. Its main features are:

- PC/104-Plus Bus slot fully compatible with PCI version 2.2 specifications.
- Integrated PCI arbitration interface (32 bit wide, 3.3V).
- Translation of PCI cycles to ISA bus.
- Translation of ISA master initiated cycle to PCI.
- Support for burst read/write from PCI master.
- 33 MHz PCI clock.

Pin	A	B	C	D
1	GND	Reserved	+5 Volts	AD00
2	VI/O	AD02	AD01	+5 Volts
3	AD05	GND	AD04	AD03
4	C/BE0	AD07	GND	AD06
5	GND	AD09	AD08	GND
6	AD11	VI/O	AD10	M66EN
7	AD14	AD13	GND	AD12
8	VBUS	C/BE1	AD15	VBUS
9	SERR	GND	SB0	PAR
10	GND	PERR	VBUS	SDONE
11	STOP	VBUS	LOCK	GND
12	VBUS	TRDY	GND	DEVSEL
13	FRAME	GND	IRDY	VBUS
14	GND	AD16	VBUS	C/BE2
15	AD18	VBUS	AD17	GND
16	AD21	AD20	GND	AD19
17	VBUS	AD23	AD22	VBUS
18	IDSEL0	GND	IDSEL	IDSEL2
19	AD24	C/BE3	VI/O	IDSEL3
20	GND	AD26	AD25	GND
21	AD29	+5 Volts	AD28	AD27
22	+5 Volts	AD30	GND	AD31
23	REQ0	GND	REQ1	VI/O
24	GND	REQ2	+5 Volts	GNT0
25	GNT1	VI/O	GNT2	GND
26	+5 Volts	CLK0	GND	CKL1
27	CLK2	+5 Volts	CLK3	GND
28	GND	INTD	+5 Volts	RST
29	+12 Volts	INTA	INTB	INTC
30	-12 Volts	REQ3	GNT3	GND



Note: All VIO pins are connected to +3.3V.
 VBUS is connected to 3.3V of J25 (optionally to internal +3.3V)
 The voltages +3.3V, +5V, 12V and -12 V are not generated by the onboard power-supply but routed from the Micro ATX Connector. The maximum current is limited to 1.0 amp each.

3.19 Mini-PCI Bus Interface (J17)

The Mini-PCI specification defines a small form factor daughter card for the 32bit PCI bus that can be used on CPU-boards in which standard PCI cards cannot be used due to mechanical constraints. A CPU board with such a card can easily be enhanced with new functionality. The onboard Type IIIA Mini PCI Slot can be used to extend the system easily with peripheral functionality, like:

- WLAN modules
- Fire Wire ports
- USB 2.0 ports

Several Mini PCI extension boards are available on request.

There are 3.3V available on the Mini-PCI Slot, powered by the onboard PSU.

Mini-PCI Type IIIA:

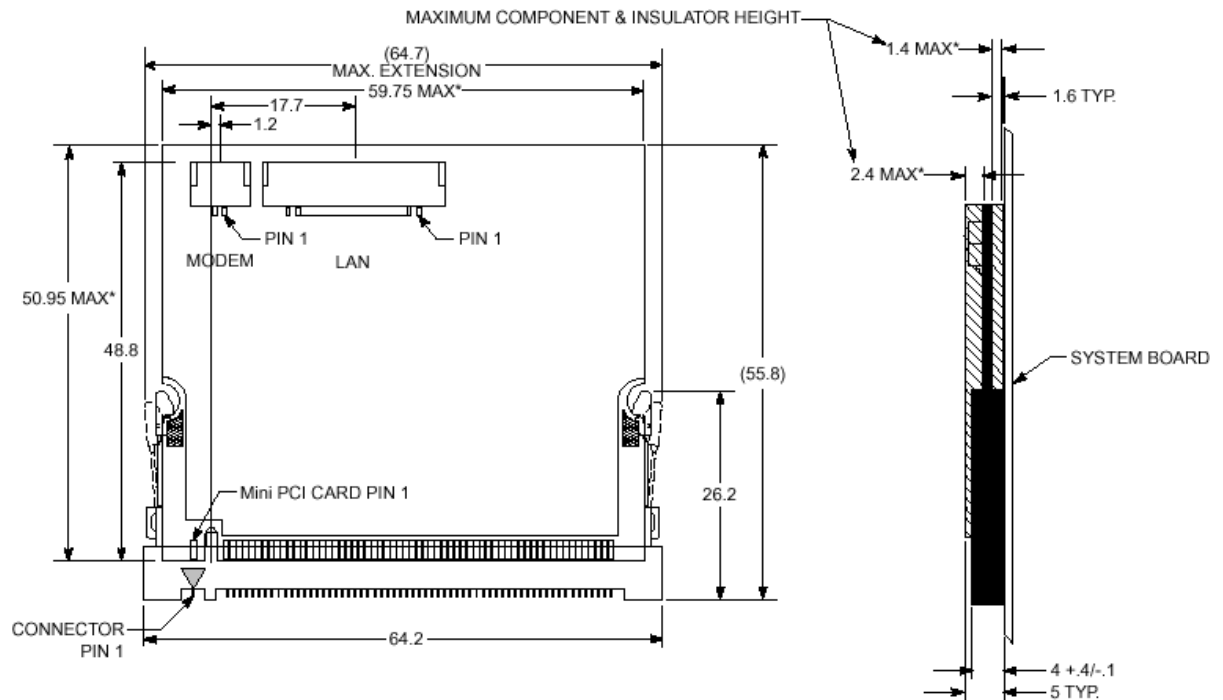

3.20 PC/104 Bus Interface (J21)

The PC/104 bus is a modification of the industry standard (ISA) PC bus specified in IEEE P996. The PC/104 bus has different mechanics than P966 to allow the stacking of modules. The main features are:

- Supports programmable extra wait state for ISA cycles
- Supports I/O recovery time for back-to-back I/O cycles

Pin	D	C
0	GND	GND
1	MEMCS16#	SBHE#
2	IOCS16#	LA23
3	IRQ10	LA22
4	IRQ11	LA21
5	IRQ12	LA20
6	IRQ15	LA19
7	IRQ14	LA18
8	DACK0#	LA17
9	DRQ0	MEMR#
10	DACK5#	MEMW#
11	DRQ5	SD8
12	DACK6#	SD9
13	DRQ6	SD10
14	DACK7#	SD11
15	DRQ7	SD12
16	+5V	SD13
17	MASTER#	SD14
18	GND	SD15
19	GND	GND

Pin		
1	IOCHCK#	GND
2	D7	RSTDRV
3	D6	+5V <small>***VDD</small>
4	D5	IRQ9
5	D4	-5V
6	D3	DRQ2
7	D2	-12V <small>***VDD</small>
8	D1	ENDXFER
9	D0	+12V
10	IOCHRDY	KEY
11	AEN	SMEMW#
12	A19	SMEMR#
13	A18	IOW#
14	A17	IOR#
15	A16	DACK3#
16	A15	DRQ3
17	A14	DACK1#
18	A13	DRQ1
19	A12	REFRESH#
20	A11	SYSCLK
21	A10	IRQ7
22	A9	IRQ6
23	A8	IRQ5
24	A7	IRQ4
25	A6	IRQ3
26	A5	DACK2#
27	A4	TC
28	A3	BALE
29	A2	+5V
30	A1	OSC
31	A0	GND
32	GND	GND

+3.3V, +12V and -12V are only routed to connectors for external I/O extension. Their current is limited to 1A each.

3.21 High Speed Data Input Port (J3, Top)

Connector type: IDC40 pin header 2.00 mm
Matching connector: IDC40 pin female connector 2.00 mm

Pin	Signal	Pin	Signal
1	+3.3 Volts	2	SYNC
3	+5 Volts	4	GND
5	CLK	6	GND
7	D0	8	GND
9	D1	10	GND
11	D2	12	GND
13	D3	14	GND
15	D4	16	GND
17	D5	18	GND
19	D6	20	GND
21	D7	22	GND
23	D8	24	GND
25	D9	26	GND
27	D10	28	GND
29	D11	30	GND
31	D12	32	GND
33	D13	34	GND
35	D14	36	GND
37	D15	38	GND
39	VSYNC	40	HSYNC

3.22 GPIO Header (J13, Top)

Connector type: IDC40 pin header 2.00 mm
 Matching connector: IDC40 pin female connector 2.00 mm

Pin	Signal	Pin	Signal
1	+3.3 Volts	2	+5 Volts
3	+3.3 Volts SBY	4	SIO_GPIO 40
5	NC	6	SIO_GPIO 41
7	SIO_GPIO 10	8	SIO_GPIO 42
9	SIO_GPIO 62	10	SIO_GPIO 43
11	SIO_GPIO 14	12	SIO_GPIO 44
13	SIO_GPIO 17	14	SIO_GPIO 45
15	SIO_GPIO 20	16	SIO_GPIO 46
17	SIO_GPIO 21	18	SIO_GPIO 47
19	SIO_GPIO 24	20	SIO_GPIO 50
21	GND	22	GND
23	SIO_GPIO 25	24	SIO_GPIO 52
25	SIO_GPIO 30	26	SIO_GPIO 53
27	SIO_GPIO 31	28	SMB_CLK
29	SIO_GPIO 32	30	SMB_DAT
31	SIO_GPIO 33	32	CS5536_GPIO25
33	SIO_GPIO 34	34	CS5536_GPIO9
35	SIO_GPIO 35	36	CS5536_GPIO8
37	SIO_GPIO 37	38	CS5536_GPIO6
39	GND	40	GND

3.23 Analog Inputs and PWM Outputs (J12, Top)

Connector type: IDC40 pin header 2.00 mm
Matching connector: IDC40 pin female connector 2.00 mm

Pin	Signal	Pin	Signal
1	+5 Volts	2	+5 Volts
3	+5 Volts	4	+5 Volts
5	NC	6	SIO_AGND
7	SIO_PWM2	8	SIO_AGND
9	SIO_PWM3	10	SIO_AGND
11	SIO_PWM4	12	SIO_AGND
13	SIO_PWM5	14	SIO_AGND
15	SIO_ADC0	16	SIO_AGND
17	SIO_ADC1	18	SIO_AGND
19	SIO_ADC2	20	SIO_AGND
21	SIO_ADC3	22	SIO_AGND
23	SIO_ADC4	24	SIO_AGND
25	SIO_ADC5	26	SIO_AGND
27	SIO_ADC6	28	SIO_AGND
29	SIO_ADC7	30	SIO_AGND
31	SIO_ADC_VREF	32	SIO_AGND
33	+3.3 Volts	34	SIO_AGND
35	+3.3 Volts	36	SIO_AGND
37	GND	38	GND
39	GND	40	GND

3.24 REQ#/GNT# Select Panel (J5=REQ#, J6=GNT#, Top)

Connector type: IDC12 pin header 2.00 mm.
Matching part: 2.0 mm jumper

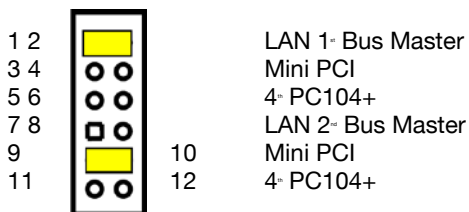

These Jumper Fields are to select two out of three PCI device to act as Bus Masters. By default the Ethernet controller and the Mini PCI extension card act as Bus Masters. In case a 4th Bus Master is needed at the PC104+ Bus, switch Jumper to desired setting. Note that Jumpers on J5 and J6 must be in the same positions.

3.25 LPC Header (J8, Top)

Connector type: IDC20 pin header 2.00 mm
Matching connector: IDC20 pin female connector 2.00 mm

Pin	Signal	Pin	Signal
1	+3.3 Volts	2	+3.3 Volts
3	GND	4	PCI_RST#
5	GND	6	CLK
7	GND	8	LPC_AD3
9	GND	10	LPC_AD2
11	GND	12	LPC_AD1
13	GND	14	LPC_AD0
15	GND	16	LPC_FRAME#
17	GND	18	SERIRQ
19	GND	20	LPC_DRQ#

3.26 Floppy connector (J20, Top)

Connector type: FFC 26 pin 1.00 mm (Hirose HRS-FH10-26)

Pin	Signal	Pin	Signal
1	+5 Volt	2	Index
3	+5 Volt	4	Drive Select 0
5	+5 Volt	6	Disk change
7	NC	8	NC
9	NC	10	Motor On 0
11	NC	12	Direction
13	NC	14	Step
15	GND	16	Write Data
17	GND	18	Write Gate
19	GND	20	Track 0
21	GND	22	Write Protect
23	GND	24	Read Data
25	GND	26	Head Select

3.27 uDOC Header (J16, Top)

Connector type: IDC10 pin header 2.54 mm
Matching part: IDC10 pin female connector 2.54 mm
 uDOC 2.54 mm
 2.54 mm jumper

Pin	Signal	Pin	Signal
1	+5 Volts	2	NC
3	USB2-	4	USB2_CON-
5	USB2+	6	USB2_CON+
7	GND	8	NC
9	KEY	10	NC



When DOC is not used, jumper pins 3 to 4 and 5 to 6 using a 2.54mm Jumper (default).

3.28 Fan Header (J11, Top)

The Hurricane LX800 provides a connector to power a system fan, if the if the environment needs additional cooling. The output voltage is minimum +3 Volts and is regulated to the temperature of the CPU.

Connector type: AMP-640456-3Pin
Matching connector: Molex 2.54mm (.100") Pitch KK® Crimp Terminal Housing, 3 Circuits

Pin	Signal
1	Speed Signal from fan (yellow)
2	+5 Volts (red)
3	GND (black)

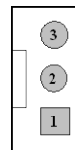

3.29 LEMT functions

The onboard Microcontroller implements power sequencing and LEMT (LiPPERT Enhanced Management Technology) functionality. The microcontroller communicates via the System Management Bus with the CPU/Chipset. The following functions are implemented:

- Total operating hours counter
Counts the number of hours the module has been run in minutes.
- On-time minutes counter
Counts the seconds since last system start.
- Temperature monitoring of CPU and Board temperature
Min. and max. temperature values of CPU and board are stored in flash.
- Power cycles counter
- System Restart Cause
Power loss / Watchdog / External Reset.
- Flash area
1kB Flash area for customer data
- Protected Flash area
128 Bytes for Keys, ID's, etc. can stored in a write- and clear-protectable region.
- Board Identify
Vendor / Board / Serial number

4 Using the Module

4.1 BIOS

The Hurricane LX800 is delivered with a standard PC BIOS. The default setting guarantees a “ready to run” system, even without a BIOS setup backup battery.

If the user wants to change settings, pressing the <F1> key on power up accesses the setup utility.

The BIOS is located in a flash PROM and can be easily updated on board with software under DOS.

All changes in the setup of the BIOS are stored in the CMOS RAM of the real time clock.

The default values of the BIOS can be automatically loaded at boot time. To achieve this, push the Reset-Button five times while the system is already booting. This will load the default values. Note that power-cycling the board five times in a row without the BIOS being able to complete its self test has the same effect.

Configuring the XpressROM BIOS

Pressing <F1> on power up starts the BIOS setup utility.

```
Insyde Technology XpressROM Setup
Version: Hurricane-LX HLX00011.BIN      (c)LIPPERT Built: 08/12/2009 17:18:10
----- Main Menu -----
A. Time 14:28:11
B. Date 11/02/2009

C. System Clock/PLL                    D. IDE and Floppy Drives
W. Power Management                   R. Serial and Parallel Ports
M. Miscellaneous                      U. Video and Flat Panel
I. ISA I/O and Memory                 G. GPIO Setting
O. Boot Order                         P. PCI Bus
L. Load Defaults                      T. Thermal and Watchdog

S. Save Values Without Exit
Q. Exit Without Save
X. Save Values and Exit

Set the current time in the RTC
```

Field Selection

To move between fields in Setup, use the keys listed below:

Key	Function
à, ß, â, á	Move between fields
+, -	Selects next/previous values in fields
Enter	Go to the submenu for the field
Esc	To previous field then to exit menu

In order to save your settings, select **Save values and Exit** and confirm with Y. Should you want to discard everything, select **Exit Without Save**.

When troubleshooting a system, it is highly recommend to first restore the BIOS's factory settings before any debugging is done. This is achieved with **Load Defaults** in the main setup menu.

The **System Clock/PLL** menu allows configuring the multipliers for CPU clock and Geode Link (DDR RAM) clock. Base clock is 33MHz.

```

Insyde Technology XpressROM Setup
Version: Hurricane-LX HLX00011.BIN      (c)LiPPERT Built: 08/12/2009 17:18:10
----- System Clock/PLL Configuration -----

Clock Mode
Clock Determined by: Manual settings

Manual PLL Settings
CPU Multiplier: 15
GeodeLink Multiplier: 10

Spread Spectrum: Enabled

33.3MHz * CPU multiplier = CPU speed

```



Note: CPU Multipliers above 15 (500Mhz) may seriously damage the CPU!

The **Drive Configuration** menu allows configuring the settings for the IDE controller.

```

Insyde Technology XpressROM Setup
Version: Hurricane-LX HLX00011.BIN      (c)LiPPERT Built: 08/12/2009 17:18:10
----- Drive Configuration -----

Hard Drive Configuration
Primary ATA Controller: Enabled
IDE BIOS Support: Enabled
Map Slave HDD First: Disabled
80-Conductor Cable Sense: GPIO 05
DMA/UDMA BIOS Support: Enabled
Force Mode for Drive 1: Auto
Force Mode for Drive 2: Auto

Floppy BIOS Support: Disabled
Force USB Floppy to Drive A: Disabled

CD-ROM Boot BIOS Support: Enabled

Enable/Disable ATA PCI header & legacy ATA descriptors

```

Hard Drive Setting	Choice
80-Conductor Cable Sense	GPIO05, NONE, Force 40, Force 80
Drive Modes	Auto, PIO0, PIO1, PIO2, PIO3, PIO4, MDMA0, MDMA1, MDMA2, UDMA0, UDMA1, UDMA2, UDMA3, UDMA4

Settings for serial and parallel ports can be made in *Serial and Parallel Port Configuration*.

```
Insyde Technology XpressROM Setup
Version: Hurricane-LX HLX00011.BIN      (c)LiPPERT Built: 08/12/2009 17:18:10
Serial and Parallel Port Configuration

Serial Port 1: 0x3F8, IRQ 4
Mode: RS232

Serial Port 2: 0x2F8, IRQ 3
Mode: RS232

Parallel Port: 0x378
Mode: Standard (SPP)
IRQ: IRQ 7
DMA: Channel 1

Configure the 1st LPC UART
```



Note: Do not forget the termination jumpers when switching to RS485 mode.

The *Power Management* menu gives control over supported power down modes.

```
Insyde Technology XpressROM Setup
Version: Hurricane-LX HLX00011.BIN      (c)LiPPERT Built: 08/12/2009 17:18:10
Power Management

Legacy BIOS PM at Boot: Disabled

Power Management APIs
APM Available: No
ACPI Available: Yes
S1 Clocks: Off (Least power)
P-State Limit: P1

Clock Gating
CPU Clock Gating: Enabled
Chipset Clock Gating: Enabled

Wake up Events
PS/2 Mouse: None
PS/2 Keyboard: None
Wake up Key: Ctrl+Esc

BIOS will turn on Legacy PM before booting the OS.
```

Miscellaneous Configuration controls various other features.

```
Insyde Technology XpressROM Setup
Version: Hurricane-LX HLX00011.BIN      (c)LiPPERT Built: 08/12/2009 17:18:10
----- Miscellaneous Configuration -----

Splash Screen Configuration
Splash Screen:      Enabled
Clear Splash Screen:  Enabled
F1 Key Timeout:      2000

Summary Screen Configuration
Summary Screen:      Enabled
Summary Screen Timeout: 0

Power Button Configuration
Instant Power On:   Enabled
Power Button:       ACPI mode

PC Speaker Configuration
AC Beeper:         Enabled

Enable/Disable display of splash screen
```

Enter *Graphics Configuration* for changing the display settings.

```
Insyde Technology XpressROM Setup
Version: Hurricane-LX HLX00011.BIN      (c)LiPPERT Built: 08/12/2009 17:18:10
----- Graphics Configuration -----

Internal Adaptor Mode: Disabled
Graphics Memory: 24                      Driver Controls Init: Disabled
Output Display: CRT                       DOTPLL Bypass:      Disabled

HSDIP Support: Disabled
HSDIP Memory Size: 4

Flat Panel Configuration
Type: LVDS                                HSYNC Polarity:     Active low
Resolution: 800x600                       VSYNC Polarity:     Active low
Data Bus Type: 7-24 bits, 1 KPC            LP Active Period:    Free running
Refresh Rate: 60 Hz                       SHPClk Active Period: Free running

Mode for internal controller when an external video device is present.
```

ISA I/O and Memory Configuration allows setting the board's ISA memory and I/O map.

```
Insyde Technology XpressROM Setup
Version: Hurricane-LX HLX00011.BIN      (c)LIPPERT Built: 08/12/2009 17:18:10
----- ISA I/O and Memory Configuration -----

I/O Mapped to ISA
I/O Range 0: Enabled      Size: 128      Base Addr (A15-A0): 0x0100
I/O Range 1: Enabled      Size: 64       Base Addr (A15-A0): 0x0180
I/O Range 2: Enabled      Size: 32       Base Addr (A15-A0): 0x01C0
I/O Range 3: Enabled      Size: 128     Base Addr (A15-A0): 0x0200
I/O Range 4: Enabled      Size: 64       Base Addr (A15-A0): 0x0300
I/O Range 5: Enabled      Size: 32       Base Addr (A15-A0): 0x0340

Memory and DMA Mapped to ISA
Mem Range 0: Enabled      Size: 32K     Base Addr (A23-A0): 0x0C8000
Mem Range 1: Enabled      Size: 64K     Base Addr (A23-A0): 0x0D0000
Mem Range 2: Disabled     Size: 16K     Base Addr (A23-A0): 0x000000
Mem Range 3: Disabled     Size: 16K     Base Addr (A23-A0): 0x000000

DMA Channel 0: Enabled
DMA Channel 1: Disabled   DMA Channel 5: Enabled
DMA Channel 2: Disabled   DMA Channel 6: Enabled
DMA Channel 3: Enabled    DMA Channel 7: Enabled

Enable/Disable mapping selected I/O addresses to ISA
```

By default the following I/O and Memory Ranges are mapped to ISA and NOT accessible for other devices any more:

- I/O: Range-0: 100h-17Fh
- Range-1: 180h-1BFh
- Range-2: 1C0h-1DFh
- Range-3: 200h-27Fh
- Range-4: 300h-33Fh
- Range-5: 340h-35Fh

- Memory: Range-0: C8000h-CFFFFh
- Range-1: D0000h-DFFFFh

If a PCI device (e.g. on an external adapter) needs some of this ranges, the space has to be freed, because the system is NOT Plug and Play! Otherwise if an external ISA card needs additional I/O or Memory space, the above ranges need to be reconfigured.



Note: You need to know exactly the resources that are needed by external cards in order to setup the BIOS correctly! Otherwise it may happen that some cards do not work properly!

PCI Configuration allows settings for IRQ steering and various PCI devices.

```
Insyde Technology XpressROM Setup
Version: Hurricane-LX HLX00011.BIN      (c)LiPPERT Built: 08/12/2009 17:18:10
----- PCI Configuration -----

PCI Interrupt Steering
PCI INTA#: IRQ 10
PCI INTB#: IRQ 11
PCI INTC#: IRQ 5
PCI INTD#: IRQ 15

USB Settings
OHCI (USB 1.1):      Enabled
EHCI (USB 2.0):     Enabled
UDC (Device):       Disabled
UOC (Device):       Disabled
Overcurrent Reporting: Disabled
Port 4 Assignment:  Host

Audio Controller:   Enabled

Additional PCI Headers
GPIO, MFGPT, SMB:  Disabled

Enable/Disable INTA# to IRQ steering
```



Note: *If you have an external ISA card that needs e.g. IRQ 5, PCI Interrupt steering must be configured in a way that none of the PCI INTs is steered to IRQ 5. In this example it would be possible to steer PCI INTC# to IRQ 10.*

GPIO6 can be made available under *GPIO Setting*.

```
Insyde Technology XpressROM Setup
Version: Hurricane-LX HLX00011.BIN      (c)LiPPERT Built: 08/12/2009 17:18:10
----- GPIO Setting -----

GPIO Pins Setting
GPIO 6: Available

Select GPIO6 pin usage
```

The **Boot Order** menu specifies the order in which the BIOS tries the various mass memory devices for a bootable operating system.

```
Insyde Technology XpressROM Setup
Version: Hurricane-LX HLX00011.BIN      (c)LiPPERT Built: 08/12/2009 17:18:10
----- Boot Order -----

Boot Order Configuration
1. Floppy Disk
2. Hard Drive
3. CD-ROM Drive
4. USB Floppy Disk
5. USB Hard Drive/Flash Drive
6. USB CD-ROM Drive
```

Some safety features can be found under **Thermal and Watchdog Configuration**.

```
Insyde Technology XpressROM Setup
Version: Hurricane-LX HLX00011.BIN      (c)LiPPERT Built: 08/12/2009 17:18:10
----- Thermal and Watchdog Configuration -----

Current Temperatures
Ambient Temperature: + 34°C
CPU Temperature:     + 43°C

Emergency Overtemp Shutoff: Disabled
Ambient Temperature Limit: 95
CPU Temperature Limit:   110

Initial Watchdog Timeout: 0

Shut off power 3 s after temperatures exceed a limit below.
```

Trouble Shooting BIOS Settings

It may happen that the BIOS is configured in a way that the Hurricane-LX800 does not start at all. To repair this, the default values of the BIOS can be automatically loaded at boot time. To load these, the power must be switched on and off again within 2 seconds. This sequence must be repeated 5 times, then the default values get loaded by the BIOS.

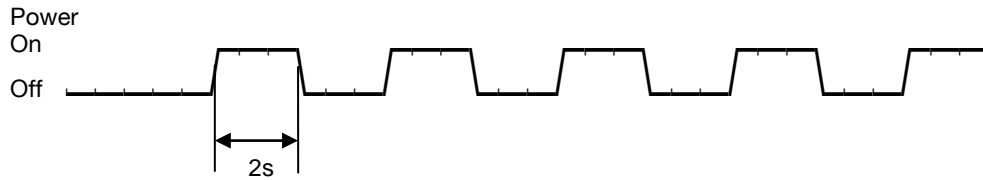

Pressing the Reset-Button five times while the system is booting achieves the same result.

4.2 Drivers

Software drivers for sound, Ethernet, AES and graphics adapter are available for the Hurricane LX800. These drivers can be downloaded from LiPPERT's website <http://www.lippertembedded.com>. For installation, follow the instructions on the driver disks.

4.3 Programming GPIO Signals

The Hurricane LX800 provides 26 General Purpose Input/Output signals (GPIOs) that are part of the ITE8712 SuperIO. These can be programmed either as input or output. Their output voltage is 5V, a 40 Kohm internal pullup resistor is optional enabled by software. They GPIOs are located in Logical Device 7 of the SuperIO and can be accessed easily with the SuperIO's 'simple IO' function using port accesses.

The following programming example is meant to be compiled using gcc under Linux.

```
#include <sys/io.h>
#include <stdio.h>

#define CONF_ADDR 0x2E
#define CONF_DATA 0x2F
#define GPIO_ADDR 0x1223

//*****
// InitGPIO: initialize GPIO Bank #4
// Parameter: mode: bit=1 -> set to GPIO
//            dir: bit=1/0 -> set to output/input
//            (char = 8 bit)
// Returns: -
//*****
void InitGPIO(char mode,char dir)
{
    // To set the SuperIO into configuration mode, the sequence
    // 0x87, 0x01, 0x55, 0x55 must be written to the configuration address.
    outb(0x87, CONF_ADDR);
    outb(0x01, CONF_ADDR);
    outb(0x55, CONF_ADDR);
    outb(0x55, CONF_ADDR);
    // Enable Logical Device 7 for programming by writing 07h to
    // register 07h of the SuperIO:
    outb(7, CONF_ADDR); //Set to logic device
    outb(7, CONF_DATA); //Number of logic device
    // Set GPIO-Set 4 Multifunction Pin Selection Register 28 to GPIO function
    // and enable the "simple I/O" function
    // Input: mode - each set bit represents a GPIO function
    outb(0x28, CONF_ADDR); // set bank #4 to GPIO
    outb((inb(CONF_DATA)|mode, CONF_DATA); // BIT: 1=GPIO , 0=other function
    outb(0xC3, CONF_ADDR); // set to simple I/O
    outb(mode, CONF_DATA); // BIT: 1=simple I/O , 0=not simple I/O
    // Define the GPIO's data direction
    // Input: dir - each set bit represents an output
    outb(0xCB, CONF_ADDR); // set direction: output/input
    outb(dir, CONF_DATA); // BIT: 1=output, 0=input
    outb(0xBB, CONF_ADDR); // enable pull-ups if acting as output
    outb(dir, CONF_DATA); // BIT: 1=pull up, 0=no pull up
    // Set the logical I/O address 0x1223 for reading and writing values
    outb(0x62, CONF_ADDR); //IO base MSB
    outb((GPIO_ADDR & 0xFF00) >> 8, CONF_DATA); // -> 0x03
    outb(0x63, CONF_ADDR); //IO base LSB
    outb((GPIO_ADDR & 0x00FF), CONF_DATA); // -> 0x93
    // Reset configuration mode to "wait for Key"
    outb(0x02, CONF_ADDR);
    outb(0x02, CONF_DATA);
}

int main()
{
    char value1=0x55,value2; //8 bit values
    iopl(3); //get all I/O rights
    InitGPIO(0xff,0xff); //Initialize GPIO:
    //set all to GPIO and all to output
    outb(value1, GPIO_ADDR); //write out value1
    printf("Write=%x", value1);
    value2 = inb(GPIO_ADDR); //read in value2
    printf(", Read=%x\n", value2);
    return 0;
}
```

For further information, please refer to chapter 8 of the ITE8712 datasheet.

4.4 Handling Of Analog Inputs

To activate all analog inputs of the Hurricane-LX800, reset the Super I/Os Extended 2 Multifunction Pin selection register 2Ch, bits 0 and 1 only. The register is located in Logical Device 07h.

The values can be read back using index/data port 295h/296h of the LPC Bus. The registers are located at addresses 20h...27h (SIO_ADC0...SIO_ADC7).

Enable scan of these pins by writing FFh to register 50h of the LPC Bus.

The conversion rate can be configured with Logical Device 4, Register F4h. Bits 7 and 6 set the conversion rate. It is set to one second per default.

Bit7	Bit6	Frequency [Hz]
0	0	1
0	1	2
1	0	4
1	1	8

4.5 Temperature readout

Since it is possible to readout the CPU and the ambient temperature, the following code in C shows how to do that. The example is meant to be compiled using gcc under Linux.

```
#include <stdio.h> //include header files
#include <sys/io.h>
#include <unistd.h>

int main() //main function
{
    char t1hex = 0x0;
    char t2hex = 0x0;

    iopl(3);

    /** needed by BIOSes prior to version 7 **
    outb(0x51,LPC_INDEX); //thermal diode mode
    outb(0x03,LPC_DATA);
    outb(0x5C,LPC_INDEX); //unlock offset regs
    outb(0x80,LPC_DATA);
    outb(0x56,LPC_INDEX); //offset adjustment CPU
    outb(0x70,LPC_DATA);
    outb(0x57,LPC_INDEX); //offset adjustment Ambient
    outb(0x3C,LPC_DATA);
    outb(0x5C,LPC_INDEX); //lock offset regs
    outb(0x00,LPC_DATA);
    /**

    printf("CPU AMBIENT\n"); //return message
    while(1)
    {
        outb(0x29,0x295); //read out CPU temp
        t1hex = inb(0x296);
        outb(0x2A,0x295); //read out Ambient temp
        t2hex = inb(0x296);
        printf("%3d %3d\r", t1hex, t2hex); //printout to the screen
        fflush(stdout);
        sleep(1);
    }
    return 0;
}
```

4.6 PWM Outputs

Programming the PWM outputs works the same way as using GPIOs or Analog inputs.

Enter configuration mode and switch to logical device 7 (via 2Eh/2Fh).

Enable PWM outputs by setting

- Bit 6 of register 27h to '0' (SIO_PWM2)
- Bit 1 of register 29h to '0' (SIO_PWM3)
- Bits 3 and 4 of register 2Ch to '1' (SIO_PWM4+5, GPIOs 24+25 will not be longer available)

Enable channels 1-3 by programming the following registers via LPC-Bus (295h/296h):

- Bits 2,1 and 0 of register 13h to '1'
- Bits 2,1 and 0 of register 14h to '1'

Set the global frequency by programming bits 6-4 of register 14h via LPC-Bus (295h/296h):

Bits 6, 5, 4	PWM frequency
000	375.000 KHz
001	187.500 KHz
010	93.750 KHz
011	62.500 KHz
100	46.875 KHz
101	23.430 KHz
110	11.700 KHz
111	5.870 KHz

Set Bit 3 of register 14h to '0' to allow duty cycles between 0...100%. (PWM/128*100%)

Duty cycles can be set different for each PWM channel by programming an 8 Bit value to registers 16h for channel 2, 17h for channel 3, 88h for channel 4 and 89h for channel 5.

5 Address Maps

This section describes the layout of the CPU memory and I/O address spaces.



Note Depending on enabled or disabled functions in the BIOS, other or more resources may be used

5.1 Memory Address Map

Address range (dec)	Address range (hex)	Size	Description
1024K - 16384K	100000 - FFFFFFFF	15360K	Extended memory
896K - 1024K	E0000 - FFFFFF	128K	System BIOS
800K - 896K	C8000 - DFFFFF	96K	Mapped to ISA (default)
768K - 800K	C0000 - C7FFF	32K	Graphics BIOS
736K - 768K	B8000 - BFFFF	32K	Color text memory
704K - 736K	B0000 - B7FFF	32K	Monochrome text memory
640K - 704K	A0000 - AFFFF	64K	Graphics memory
639K - 640K	9FC00 - 9FFFF	1K	EBDA
0K - 639K	0 - 9FBFF	639K	Conventional memory

5.2 I/O Address Map

The system chip set implements a number of registers in I/O address space. These registers occupy the following map in the I/O space:

Address range (hex)	Description
0000 - 000F	DMA controller
0020 - 0021	Programmable interrupt controller
002E - 002F	Super I/O
0040 - 0043	System timer
0048 - 004B	System timer
0060 - 0060	Keyboard
0061 - 0061	System speaker
0064 - 0064	Keyboard
0070 - 0073	System CMOS / Real-time clock
0080 - 008F	DMA controller
0092 - 0092	System
00A0 - 00A1	Programmable interrupt controller
00C0 - 00DF	DMA controller
00F0 - 00FF	Numeric coprocessor
0100 - 017F	*PCI-ISA bridge positive decode range 1 (default)
0180 - 01BF	*PCI-ISA bridge positive decode range 2 (default)
01C0 - 01DF	*PCI-ISA bridge positive decode range 3 (default)
01F0 - 01FF	*IDE controller
0200 - 027F	*PCI-ISA bridge positive decode range 4 (default)
0279 - 0279	(ISA-PnP data port)
0290 - 0297	Environment controller
0298 - 029B	PME direct access
02F8 - 02FF	*Serial port 2
0300 - 033F	*PCI-ISA bridge positive decode range 5 (default)
0340 - 035F	*PCI-ISA bridge positive decode range 6 (default)
0378 - 037F	*Parallel port
03B0 - 03BA	VGA
03C0 - 03DF	VGA
03F0 - 03F7	Floppy controller
03F8 - 03FF	*Serial port 1
0480 - 048F	DMA controller
04D0 - 04D1	Programmable interrupt controller
0A79 - 0A79	(ISA-PnP data port)
0CF8 - 0CFF	PCI config space
1220 - 1227	Simple-I/O
1228 - 122F	SPI flash
1390 - 13FF	*DDMA controller
AC1C - AC1F	VSA

* Item can be moved or disabled in BIOS Setup

5.3 Interrupts

IRQ	System Resource
-----	-----------------

0	Timer
1	Keyboard
2	(Secondary interrupt controller)
3	Serial port 2
4	Serial port 1
5	PCI INTC# (Ethernet)
6	Floppy
7	Parallel port
8	Real time clock
9	ACPI (Environment controller)
10	PCI INTA# (Mini-PCI- B, graphics, AES)
11	PCI INTB# (Mini-PCI- A, audio, misc. CS5536)
12	PS/2 mouse
13	Numeric coprocessor
14	Primary IDE channel
15	PCI INTD# (USB)

5.4 DMA Channels

DMA	Data width	System Resource
0	8 bits	Available
1	8 bits	Parallel Port (ECP mode)
2	8 bits	Floppy
3	8 bits	Available
4		Reserved, Cascade Channel
5	16 bits	Available
6	16 bits	Available
7	16 bits	Available

Appendix A, Contact Information

Headquarters

LiPPERT Embedded Computers GmbH
Hans-Thoma-Straße 11
68163 Mannheim
Germany

Phone	+49 621 43214-0
Fax	+49 621 4321430
E-mail	sales@lippertembedded.com support@lippertembedded.com
Website	www.lippertembedded.com

US Office

LiPPERT Embedded Computers, Inc.
2220 Northmont Parkway Suite 250
Duluth, GA 30096
USA

Phone	+1 (770) 295 0031
Fax	+1 (678) 417 6273
E-mail	ussales@lippertembedded.com support@lippertembedded.com
Website	www.lippertembedded.com

Appendix B, Additional Information

B.1 Additional Reading

AMD Geode™ LX Processors Data Book

AMD Geode™ CS5536 Companion Device Data Book

Datasheet LPC interface Winbond 83627HF, available at <http://www.winbond.com>

B.2 PC/104 and PC/104-Plus Specifications

A copy of the latest PC/104 and PC104-Plus specifications can be obtained from the PC/104 Consortium's website at <http://www.pc104.org>

Appendix C, Getting Help

Should you have technical questions that are not covered by the respective manuals, please contact our support department at support@lippertembedded.com .

Please allow one working day for an answer!

Technical manuals as well as other literature for all LiPPERT products can be found in the *Products* section of LiPPERT's website www.lippertembedded.com. Simply locate the product in question and follow the link to its manual.

Returning Products for Repair

To return a product to LiPPERT for repair, you need to get a Return Material Acceptance (RMA) number first. Please print the RMA Request Form from <http://www.lippertembedded.com/service/repairs.html> fill in the blanks and fax it to +49 621 4321430. We'll return it to you with the RMA number.

Deliveries without a valid RMA number are returned to sender at his own cost!

LiPPERT has a written Warranty and Repair Policy, which can be retrieved from http://www.lippertembedded.com/media/downloads/General/BM14007_1V6.pdf

It describes how defective products are handled and what the related costs are. Please read this document carefully before returning a product.

Appendix D, Revision History

Filename	Date	Edited by	Change
TME-EPIC-HURRICANE-R0V0	2006-04-27	O. Freudenberg	Draft
TME-EPIC-HURRICANE-R1V0	2006-06-12	O. Freudenberg	Released version
TME-EPIC-HURRICANE-R1V1	2006-06-19	O. Freudenberg	Corrected chapter 4.19, description of J30-6
TME-EPIC-HURRICANE-R1V2	2006-08-01	O. Freudenberg	Edited chapter 2.24 Added chapter 2.17.1
TME-EPIC-HURRICANE-R1V3	2006-09-27	O. Freudenberg	Memory and I/O Address Maps corrected
TME-EPIC-HURLX-R1V4	2007-12-10	M. Sander	Example codes New document layout
TME-EPIC-HURLX-R1V5	2008-06-05	J. Rottmann	RS485, ISA-Bus, Watchdog, ACPI with Linux, minor changes and typos
TME-EPIC-HURLX-R1V6	2008-12-09	C. Speck	BIOS screen shots updated 4.1
TME-EPIC-HURLX-R1V7	2008-12-19	PK	Description for serial interface's jumpers added
TME-EPIC-HURLX-R1V8	2009-02-10	MS	Watchdog programming example corrected
TME-EPIC-HURLX-R3V0	2009-05-25	OF/PK	Adaptions to PCB Revision 3V0 <ul style="list-style-type: none"> o Fan supply is 5V only o SMBus is now available on J13 o LEMT now available o New Blockdiagramm Corrected electr. Specs in ch. 1.3 New dimension drawings in ch. 2.1 Chapter 3 revised
	2009-05-27	JR	Address maps corrected
	2009-08-25	OF	Added description of J31
TME-EPIC-HURLX-R3V1	2009-11-10	OF	Added LVDS color map BIOS description adapted to HLX00011.BIN
TME-EPIC-HURLX-R3V2	2009-11-26	JR	Ch. 5.2: HLX00012.BIN moved SPI and DDMA I/O ranges
	2009-12-07	OF	Added Ch. 3.26 Fan Connector
TME-EPIC-HURLX-R3V3	2010-01-25	OF	Added description of REQ#/GNT# jumpers
	2010-03-03		Corrected pinout of PC/104
	2010-04-29		Corrected pinout of PC/104-Plus
TME-EPIC-HURLX-R3V4	2010-07-28	MS	Matching parts / connectors added
TME-EPIC-HURLX-R3V5	2011-04-01	MF	Ch.3.16 Internal battery included